

■ Features :

- Universal AC input / Full range
- Low leakage current $\leq 0.3\text{mA}$
- Protections: Short circuit/Over load/Over voltage
- Cooling by free air convection
- 100% full load burn-in test
- Fixed switching frequency at 45KHz
- 3 years warranty



SPECIFICATION

MODEL	MPS-65-3.3	MPS-65-5	MPS-65-7.5	MPS-65-12	MPS-65-13.5	MPS-65-15	MPS-65-24	MPS-65-27	MPS-65-48		
OUTPUT	DC VOLTAGE	3.3V	5V	7.5V	12V	13.5V	15V	24V	27V	48V	
	RATED CURRENT	12A	12A	8A	5.2A	4.7A	4.2A	2.7A	2.4A	1.35A	
	CURRENT RANGE	0 ~ 15.2A	0 ~ 13.8A	0 ~ 9.6A	0 ~ 6A	0 ~ 5.4A	0 ~ 4.8A	0 ~ 3A	0 ~ 2.7A	0 ~ 1.5A	
	RATED POWER	39.6W	60W	60W	62.4W	63.5W	63W	64.8W	64.8W	64.8W	
	OUTPUT POWER (max.)	72W(+3.3V:50W;+5V:69W)with 18CFM min. Forced air convection									
	RIPPLE & NOISE (max.) Note.2	80mVp-p	100mVp-p	100mVp-p	100mVp-p	100mVp-p	100mVp-p	100mVp-p	100mVp-p	100mVp-p	
	VOLTAGE ADJ. RANGE	2.97 ~ 3.63V	4.5 ~ 5.5V	6.75 ~ 8.25V	10.8 ~ 13.2V	12.2 ~ 14.85V	13.5 ~ 16.5V	21.6 ~ 26.4V	24.3 ~ 29.7V	43.2 ~ 52.8V	
	VOLTAGE TOLERANCE Note.3	$\pm 3.0\%$	$\pm 3.0\%$	$\pm 3.0\%$	$\pm 2.0\%$	$\pm 2.0\%$	$\pm 2.0\%$	$\pm 2.0\%$	$\pm 2.0\%$	$\pm 2.0\%$	
	LINE REGULATION	$\pm 1.0\%$	$\pm 1.0\%$	$\pm 1.0\%$	$\pm 1.0\%$	$\pm 1.0\%$	$\pm 1.0\%$	$\pm 1.0\%$	$\pm 1.0\%$	$\pm 1.0\%$	
	LOAD REGULATION	$\pm 3.0\%$	$\pm 3.0\%$	$\pm 3.0\%$	$\pm 2.0\%$	$\pm 2.0\%$	$\pm 2.0\%$	$\pm 2.0\%$	$\pm 2.0\%$	$\pm 2.0\%$	
SETUP, RISE TIME	800ms, 30ms/230VAC		800ms, 30ms/115VAC at full load								
HOLD TIME (Typ.)	50ms/230VAC		16ms/115VAC at full load								
INPUT	VOLTAGE RANGE	90 ~ 264VAC		127 ~ 370VDC							
	FREQUENCY RANGE	47 ~ 440Hz									
	EFFICIENCY(Typ.)	66%	74%	76%	77%	78%	79%	80%	80%	80%	
	AC CURRENT (Typ.)	1.6A/115VAC		0.9A/230VAC							
	INRUSH CURRENT (Typ.)	COLD START 15A/115VAC		30A/230VAC							
LEAKAGE CURRENT	<0.3mA / 264VAC										
PROTECTION	OVER LOAD	73 ~ 105W (3.3V:51 ~ 75W)(5V:70 ~ 105W) rated output power									
		Protection type : Hiccup mode, recovers automatically after fault condition is removed									
	OVER VOLTAGE	3.8 ~ 4.46V	5.75 ~ 6.75V	8.63 ~ 10.1V	13.8 ~ 16.2V	15.5 ~ 18.2V	17.25 ~ 20.25V	27.6 ~ 32.4V	31 ~ 36.45V	55.2 ~ 64.8V	
		Protection type : Hiccup mode, recovers automatically after fault condition is removed									
ENVIRONMENT	WORKING TEMP.	-10 ~ +60°C (Refer to output load derating curve)									
	WORKING HUMIDITY	20 ~ 90% RH non-condensing									
	STORAGE TEMP., HUMIDITY	-20 ~ +85°C, 10 ~ 95% RH									
	TEMP. COEFFICIENT	$\pm 0.04\%/^{\circ}\text{C}$ (0 ~ 50°C)									
VIBRATION	10 ~ 500Hz, 2G 10min./1cycle, Period for 60min.each along X, Y, Z axes										
SAFETY & EMC (Note 4)	SAFETY STANDARDS	UL2601-1, TUV EN60601-1, IEC601-1 Approved									
	WITHSTAND VOLTAGE	I/P-O/P:4KVAC			I/P-FG:1.5KVAC		O/P-FG:0.5KVAC				
	ISOLATION RESISTANCE	I/P-O/P, I/P-FG:100M Ohms/500VDC									
	EMI CONDUCTION & RADIATION	Compliance to EN55011 (CISPR11) Class B									
	HARMONIC CURRENT	Compliance to EN61000-3-2,-3									
EMS IMMUNITY	Compliance to EN61000-4-2,3,4,5,6,8,11; ENV50204, EN60601-1-2 Medical level, criteria A										
OTHERS	MTBF	359.7Khrs min. MIL-HDBK-217F (25°C)									
	DIMENSION	127*76.2*42mm (L*W*H)									
	PACKING	0.23Kg; 54pcs/14.6Kg/1.35CUFT									
NOTE	<ol style="list-style-type: none"> 1. All parameters NOT specially mentioned are measured at 230VAC input, rated load and 25°C of ambient temperature. 2. Ripple & noise are measured at 20MHz of bandwidth by using a 12" twisted pair-wire terminated with a 0.1uF & 47uF parallel capacitor. 3. Tolerance : includes set up tolerance, line regulation and load regulation. 4. The power supply is considered a component which will be installed into a final equipment. The final equipment must be re-confirmed that it still meets EMC directives. 5. Mounting holes M1 and M2 should be grounded for EMI purposes. 										

Mechanical Specification

Unit:mm

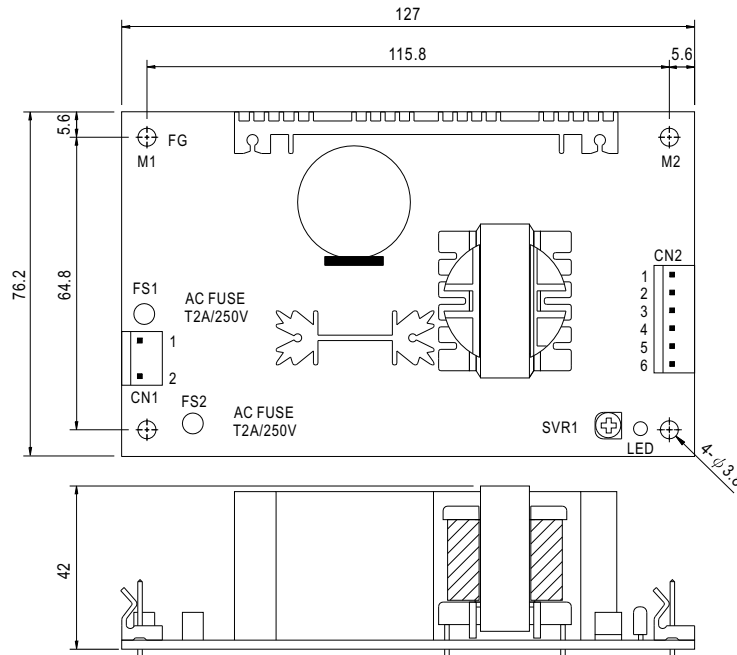

AC Input Connector (CN1) : Molex 5277-02 or equivalent

Pin No.	Assignment	Mating Housing	Terminal
1	AC/L	Molex 5195 or equivalent	Molex 5194 or equivalent
2	AC/N		

DC Output Connector (CN2) : Molex 5273-06 or equivalent

Pin No.	Assignment	Mating Housing	Terminal
1,2,3	+V	Molex 5195 or equivalent	Molex 5194 or equivalent
4,5,6	-V		

Block Diagram

fosc : 45KHz

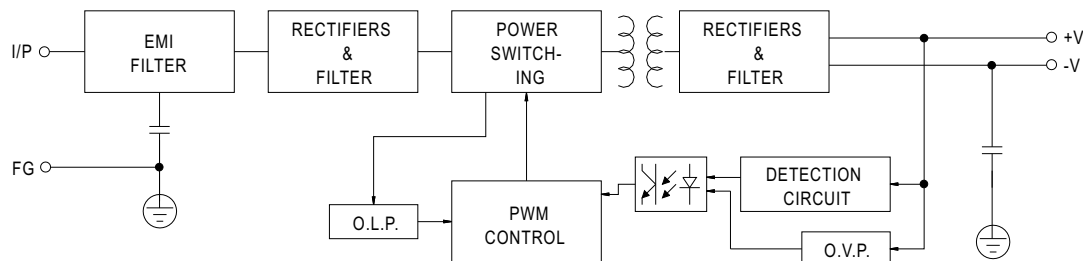

Output Derating

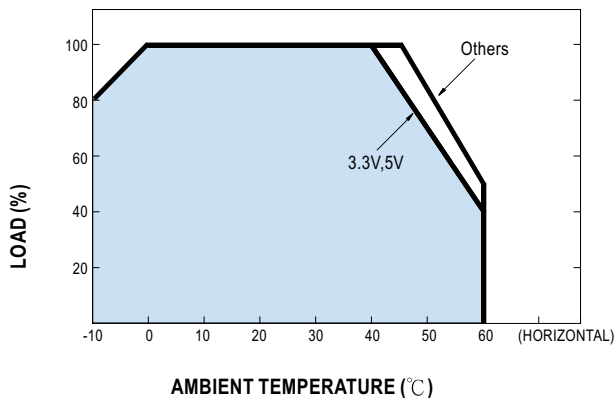

Static Characteristics

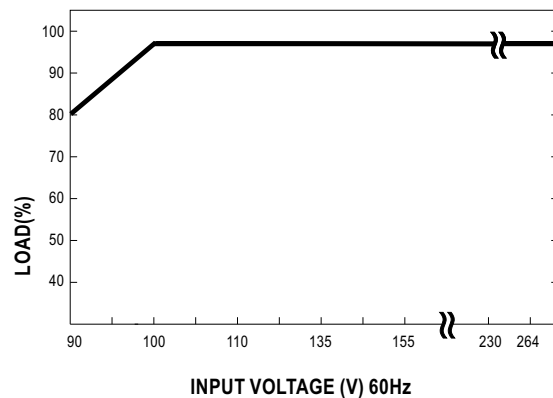

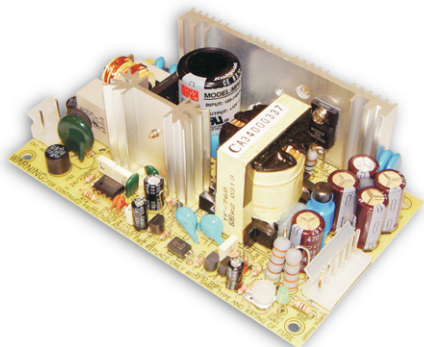

■ Features :

- Universal AC input / Full range
- Low leakage current $\leq 0.3\text{mA}$
- Protections: Short circuit/Over load/Over voltage
- Cooling by free air convection
- 100% full load burn-in test
- Fixed switching frequency at 45KHz
- 3 years warranty



SPECIFICATION

MODEL		MPD-65A		MPD-65B	
OUTPUT	OUTPUT NUMBER	CH1	CH2	CH1	CH2
	DC VOLTAGE	5V	12V	5V	24V
	RATED CURRENT	5.5A	2.8A	3.5A	2A
	CURRENT RANGE	0.4 ~ 7A	0.2 ~ 3.2A	0.4 ~ 6A	0.2 ~ 2.6A
	RATED POWER	61.1W		65.5W	
	OUTPUT POWER (max.)	72W with 18CFM min. Forced air convection			
	RIPPLE & NOISE (max.) Note.2	60mVp-p	150mVp-p	60mVp-p	150mVp-p
	VOLTAGE ADJ. RANGE	CH1:4.5 ~ 5.5V		CH1:4.5 ~ 5.5V	
	VOLTAGE TOLERANCE Note.3	$\pm 4.0\%$	$\pm 7.0\%$	$\pm 4.0\%$	$\pm 7.0\%$
	LINE REGULATION	$\pm 1.0\%$	$\pm 2.0\%$	$\pm 1.0\%$	$\pm 2.0\%$
	LOAD REGULATION	$\pm 3.0\%$	$\pm 4.0\%$	$\pm 3.0\%$	$\pm 4.0\%$
	SETUP, RISE TIME	800ms, 20ms/230VAC 800ms, 20ms/115VAC at full load			
HOLD TIME (Typ.)	80ms/230VAC 12ms/115VAC at full load				
INPUT	VOLTAGE RANGE	90 ~ 264VAC	127 ~ 370VDC		
	FREQUENCY RANGE	47 ~ 440Hz			
	EFFICIENCY(Typ.)	75%		78%	
	AC CURRENT (Typ.)	1.6A/115VAC	1A/230VAC		
	INRUSH CURRENT (Typ.)	COLD START 20A/115VAC	40A/230VAC		
LEAKAGE CURRENT	<0.3mA / 264VAC				
PROTECTION	OVER LOAD	73 ~ 105W rated output power Protection type : Hiccup mode, recovers automatically after fault condition is removed			
	OVER VOLTAGE	5.75 ~ 6.75VDC on CH1 Protection type : Hiccup mode, recovers automatically after fault condition is removed			
ENVIRONMENT	WORKING TEMP.	-10 ~ +55°C (Refer to output load derating curve)			
	WORKING HUMIDITY	20 ~ 90% RH non-condensing			
	STORAGE TEMP., HUMIDITY	-20 ~ +85°C, 10 ~ 95% RH			
	TEMP. COEFFICIENT	$\pm 0.04\%/^{\circ}\text{C}$ (0 ~ 50°C) on +5V output			
VIBRATION	10 ~ 500Hz, 2G 10min./1cycle, Period for 60min.each along X, Y, Z axes				
SAFETY & EMC (Note 4)	SAFETY STANDARDS	UL2601-1, TUV EN60601-1, IEC601-1 Approved			
	WITHSTAND VOLTAGE	I/P-O/P:4KVAC I/P-FG:1.5KVAC O/P-FG:0.5KVAC			
	ISOLATION RESISTANCE	I/P-O/P, I/P-FG:100M Ohms/500VDC			
	EMI CONDUCTION & RADIATION	Compliance to EN55011 (CISPR11) Class B			
	HARMONIC CURRENT	Compliance to EN61000-3-2,-3			
EMS IMMUNITY	Compliance to EN61000-4-2,3,4,5,6,8,11; ENV50204, EN60601-1-2 Medical level, criteria A				
OTHERS	MTBF	291.3Khrs min. MIL-HDBK-217F (25°C)			
	DIMENSION	127*76.2*42mm (L*W*H)			
	PACKING	0.25Kg; 54pcs/16Kg/1.35CUFT			
NOTE	<ol style="list-style-type: none"> 1. All parameters NOT specially mentioned are measured at 230VAC input, rated load and 25°C of ambient temperature. 2. Ripple & noise are measured at 20MHz of bandwidth by using a 12" twisted pair-wire terminated with a 0.1uf & 47uf parallel capacitor. 3. Tolerance : includes set up tolerance, line regulation and load regulation. 4. The power supply is considered a component which will be installed into a final equipment. The final equipment must be re-confirmed that it still meets EMC directives. 5. Mounting holes M1 and M2 should be grounded for EMI purposes. 				

Mechanical Specification

Unit:mm

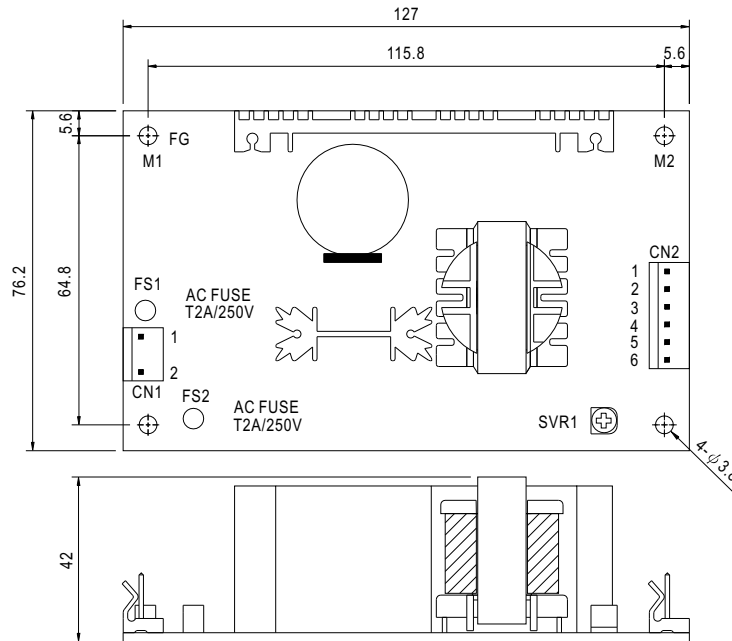

AC Input Connector (CN1) : Molex 5277-02 or equivalent

Pin No.	Assignment	Mating Housing	Terminal
1	AC/N	Molex 5195 or equivalent	Molex 5194 or equivalent
2	AC/L		

DC Output Connector (CN2) : Molex 5273-06 or equivalent

Pin No.	Assignment	Mating Housing	Terminal
1	+V	Molex 5195 or equivalent	Molex 5194 or equivalent
2,3	+5V		
4,5	COM		
6	NC		

Block Diagram

fosc : 45KHz

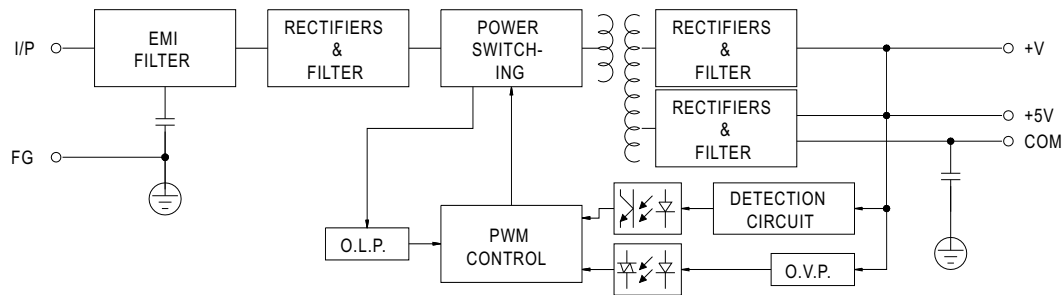

Output Derating

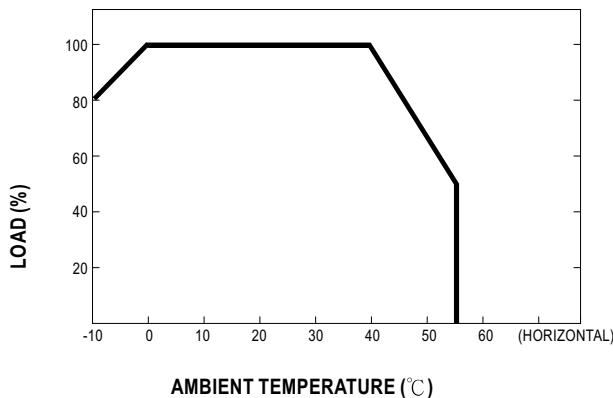

Static Characteristics

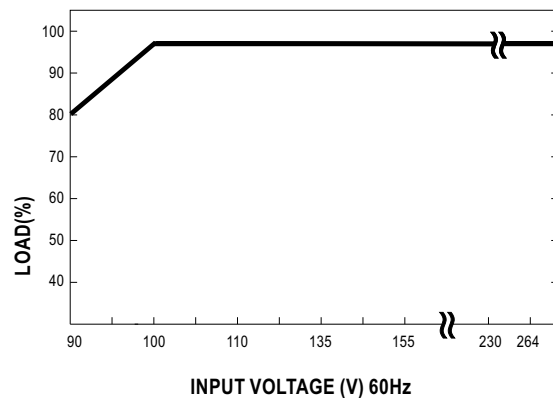

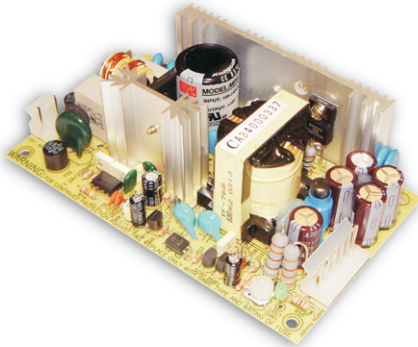

■ Features :

- Universal AC input / Full range
- Low leakage current $\leq 0.3\text{mA}$
- Protections: Short circuit/Over load/Over voltage
- Cooling by free air convection
- 100% full load burn-in test
- Fixed switching frequency at 45KHz
- 3 years warranty



SPECIFICATION

MODEL		MPT-65A			MPT-65B			MPT-65C		
OUTPUT	OUTPUT NUMBER	CH1	CH2	CH3	CH1	CH2	CH3	CH1	CH2	CH3
	DC VOLTAGE	5V	12V	-5V	5V	12V	-12V	5V	15V	-15V
	RATED CURRENT	5.5A	2.5A	0.5A	5.5A	2.5A	0.5A	5.5A	2A	0.5A
	CURRENT RANGE	0.4 ~ 7A	0.2 ~ 3.2A	0 ~ 0.7A	0.4 ~ 7A	0.2 ~ 3.2A	0 ~ 0.7A	0.4 ~ 7A	0.2 ~ 2.6A	0 ~ 0.7A
	RATED POWER	60W			63.5W			65W		
	OUTPUT POWER (max.)	72W with 18CFM min. Forced air convection								
	RIPPLE & NOISE (max.) Note.2	60mVp-p	120mVp-p	60mVp-p	60mVp-p	160mVp-p	100mVp-p	60mVp-p	180mVp-p	100mVp-p
	VOLTAGE ADJ. RANGE	CH1: 4.5 ~ 5.5V								
	VOLTAGE TOLERANCE Note.3	$\pm 4.0\%$	$+10, -7\%$	$\pm 5.0\%$	$\pm 4.0\%$	$+10, -7\%$	$\pm 5.0\%$	$\pm 4.0\%$	$+10, -7\%$	$\pm 5.0\%$
	LINE REGULATION	$\pm 1.0\%$	$\pm 2.0\%$	$\pm 1.0\%$	$\pm 1.0\%$	$\pm 2.0\%$	$\pm 1.0\%$	$\pm 1.0\%$	$\pm 2.0\%$	$\pm 1.0\%$
LOAD REGULATION	$\pm 3.0\%$	$\pm 4.0\%$	$\pm 1.0\%$	$\pm 3.0\%$	$\pm 4.0\%$	$\pm 1.0\%$	$\pm 3.0\%$	$\pm 4.0\%$	$\pm 1.0\%$	
SETUP, RISE TIME	800ms, 20ms/230VAC			800ms, 20ms/115VAC at full load						
HOLD TIME (Typ.)	80ms/230VAC			12ms/115VAC at full load						
INPUT	VOLTAGE RANGE	90 ~ 264VAC		127 ~ 370VDC						
	FREQUENCY RANGE	47 ~ 440Hz								
	EFFICIENCY(Typ.)	74%			74%			74%		
	AC CURRENT (Typ.)	1.6A/115VAC		1A/230VAC						
	INRUSH CURRENT (Typ.)	COLD START 20A/115VAC			40A/230VAC					
LEAKAGE CURRENT	<0.3mA / 264VAC									
PROTECTION	OVER LOAD	73 ~ 95W rated output power Protection type : Hiccup mode, recovers automatically after fault condition is removed								
	OVER VOLTAGE	5.75 ~ 6.75VDC on CH1 Protection type : Hiccup mode, recovers automatically after fault condition is removed								
ENVIRONMENT	WORKING TEMP.	-10 ~ +55°C (Refer to output load derating curve)								
	WORKING HUMIDITY	20 ~ 90% RH non-condensing								
	STORAGE TEMP., HUMIDITY	-20 ~ +85°C, 10 ~ 95% RH								
	TEMP. COEFFICIENT	$\pm 0.04\%/^{\circ}\text{C}$ (0 ~ 50°C) on +5V output								
VIBRATION	10 ~ 500Hz, 2G 10min./1cycle, Period for 60min.each along X, Y, Z axes									
SAFETY & EMC (Note 4)	SAFETY STANDARDS	UL2601-1, TUV EN60601-1, IEC601-1 Approved								
	WITHSTAND VOLTAGE	I/P-O/P: 4KVAC I/P-FG: 1.5KVAC O/P-FG: 0.5KVAC 1min.								
	ISOLATION RESISTANCE	I/P-O/P, I/P-FG: 100M Ohms/500VDC								
	EMI CONDUCTION & RADIATION	Compliance to EN55011 (CISPR11) Class B								
	HARMONIC CURRENT	Compliance to EN61000-3-2, -3								
EMS IMMUNITY	Compliance to EN61000-4-2, 3, 4, 5, 6, 8, 11; ENV50204, EN60601-1-2 Medical level, criteria A									
OTHERS	MTBF	275.1Khrs min. MIL-HDBK-217F (25°C)								
	DIMENSION	127*76.2*42mm (L*W*H)								
	PACKING	0.27Kg; 54pcs/16.8Kg/1.35CUFT								
NOTE	<ol style="list-style-type: none"> 1. All parameters NOT specially mentioned are measured at 230VAC input, rated load and 25°C of ambient temperature. 2. Ripple & noise are measured at 20MHz of bandwidth by using a 12" twisted pair-wire terminated with a 0.1uf & 47uf parallel capacitor. 3. Tolerance : includes set up tolerance, line regulation and load regulation. 4. The power supply is considered a component which will be installed into a final equipment. The final equipment must be re-confirmed that it still meets EMC directives. 5. Mounting holes M1 and M2 should be grounded for EMI purposes. 									

Mechanical Specification

Unit:mm

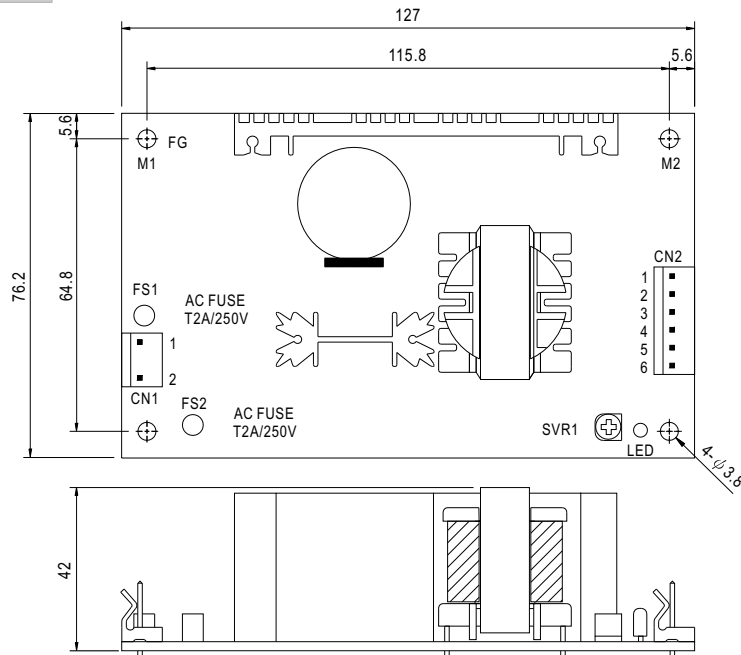

AC Input Connector (CN1) : Molex 5277-02 or equivalent

Pin No.	Assignment	Mating Housing	Terminal
1	AC/L	Molex 5195 or equivalent	Molex 5194 or equivalent
2	AC/N		

DC Output Connector (CN2) : Molex 5273-06 or equivalent

Pin No.	Assignment	Mating Housing	Terminal
1	+V	Molex 5195 or equivalent	Molex 5194 or equivalent
2,3	+5V		
4,5	COM		
6	-V		

Block Diagram

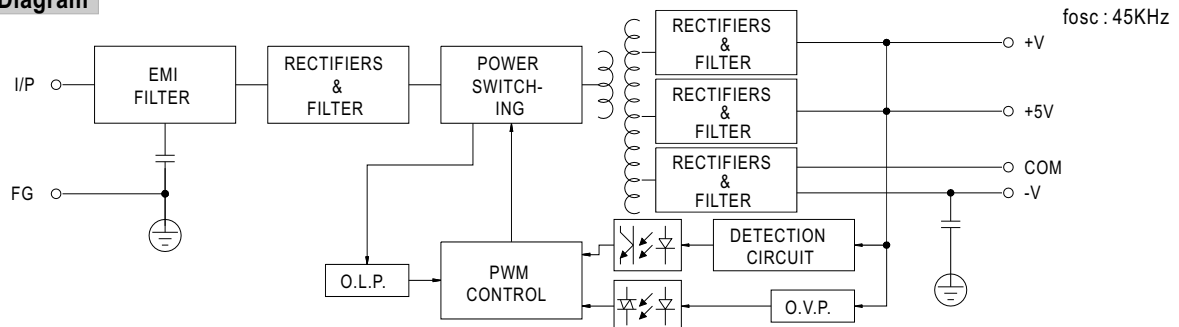

Output Derating

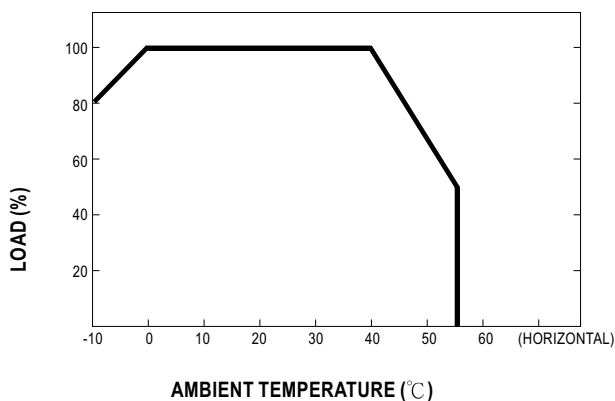

Static Characteristics

